

METAL ROOF PANELS TRIMS ACCESSORIES



add
beauty
and
life
with
a
metal
roof



contents

Investing in a metal roof? You can rely on Watson Metals to provide a complete product line of high quality metal building panels, trims, and accessories. All custom made to your exacting specifications.

Watson Metals, LLC is not just another metal building component manufacturer. You'll discover that we're one of the few metal component manufacturers who will sell direct to you...both the individual and the contractor alike. We offer the same value, service, and quality to all of our customers.

With a variety of standing seam metal panel profiles to chose from such as 1-1/2" Snap Lock, 1" Nailer Strip, and 2" Watson Lock, we can provide panels for most any application. Our standing seam profiles are available in multiple widths and a wide variety of colors, and can be produced conveniently on your job site utilizing our portable roll-former, or your product can be picked up at our store location.

All of our exposed fastened and standing seam panels and accessories carry a 40 year warranty for your protection and peace of mind. We take great pride in our ability to offer options that suit you, our customer, the way it should be...not some rigid policy dictated by a corporate office located at a distant location.

If you need assistance with your roofing installation we can provide a list of Watson Metals approved contractors who are experienced with the installation of our wide line of products and accessories.

Now that you know a little about Watson Metals...how can we help you?

| | |
|---|--------------|
| metal panels | 3 |
| 1" Nailer Strip | |
| 550 1-1/2" Snap Lock | |
| 450 1-1/2" Snap Lock | |
| Watson Lock | |
| Tuff Rib | |
| R-Panel | |
| Wave Panel | |
| 5V Crimp | |
| light gauge trims | 4-9 |
| standing seam trims | 10-13 |
| secondary framing | 14 |
| gutter and accessories | 15-16 |
| misc accessories | 17-19 |
| optional metal panels /adhesives | 20 |
| standing seam tools | 21 |
| slope charts | 22-23 |
| sliding door system | 24 |
| graph sheet | 25 |
| panel specifications | 26-27 |

standing seam panels

1" NAILER STRIP

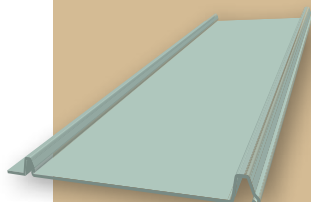

- ▲ 1" Rib Height
- ▲ 12" - 16" Overall Coverage
- ▲ Snap Locking Seams
- ▲ Hidden Fastener in Nailer Flange Fastening System
- ▲ Must be Installed over Solid Substrate Only



550 1-1/2" SNAP LOCK

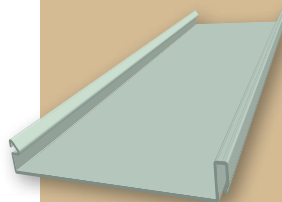

- ▲ Ribs 1-1/2" Tall
- ▲ 12" - 19" Overall Coverage
- ▲ Snap Locking Seams
- ▲ Hidden Fastener with Clips 24" o/c
- ▲ May be Installed over Solid Substrate on Purlins 24" o/c



450 1-1/2" SNAP LOCK

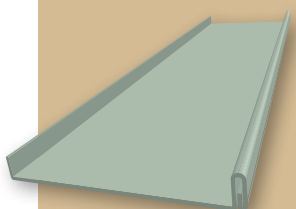

- ▲ Ribs 1 1/2" Tall
- ▲ 12" - 19" Overall Coverage
- ▲ Snap Locking Seams
- ▲ Hidden Fastener with Clips 24" o/c
- ▲ May be Installed over Solid Substrate

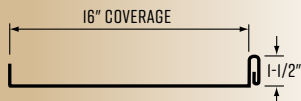

WATSON LOCK

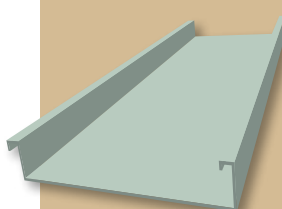

- ▲ Ribs 2" Tall
- ▲ 12" - 18" Overall Coverage
- ▲ Single or Double Lock Mechanical Seams with Hot Melt Adhesive
- ▲ Hidden Fastener with Clips 24" o/c
- ▲ May be Installed over Solid Substrate on Purlins 5' o/c

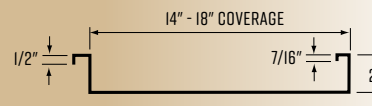

exposed fasten panels

TUFF RIB

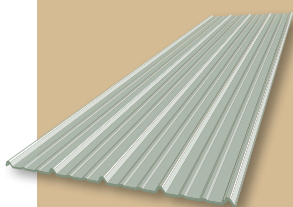

- ▲ Ribs 3/4" Tall 9" on Center
- ▲ 36" Overall Coverage
- ▲ Sidelap with Anti-Siphon Groove



R-PANEL

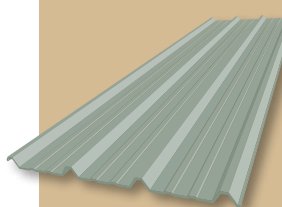

- ▲ Ribs 1-1/4" Tall 12" on Center
- ▲ 36" Overall Coverage
- ▲ Sidelap with Anti-Siphon Groove
- ▲ Works best over Solid Substrate or Purlins 60" o/c or Less

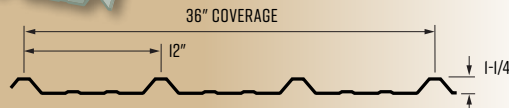

WAVE PANEL

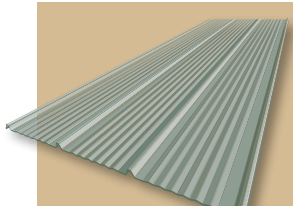

- ▲ Ribs 12" on Center
- ▲ 36" Overall Coverage
- ▲ One less rib = less screws
- ▲ Mimics standing seam



5V CRIMP

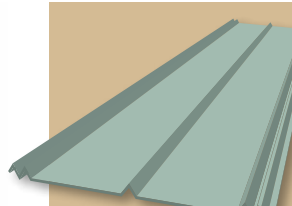

- ▲ Ribs 7/16" Tall 12" on Center
- ▲ 24" Overall Coverage
- ▲ Exposed Fastener system
- ▲ Works best over Solid Substrate



light gauge trim locator

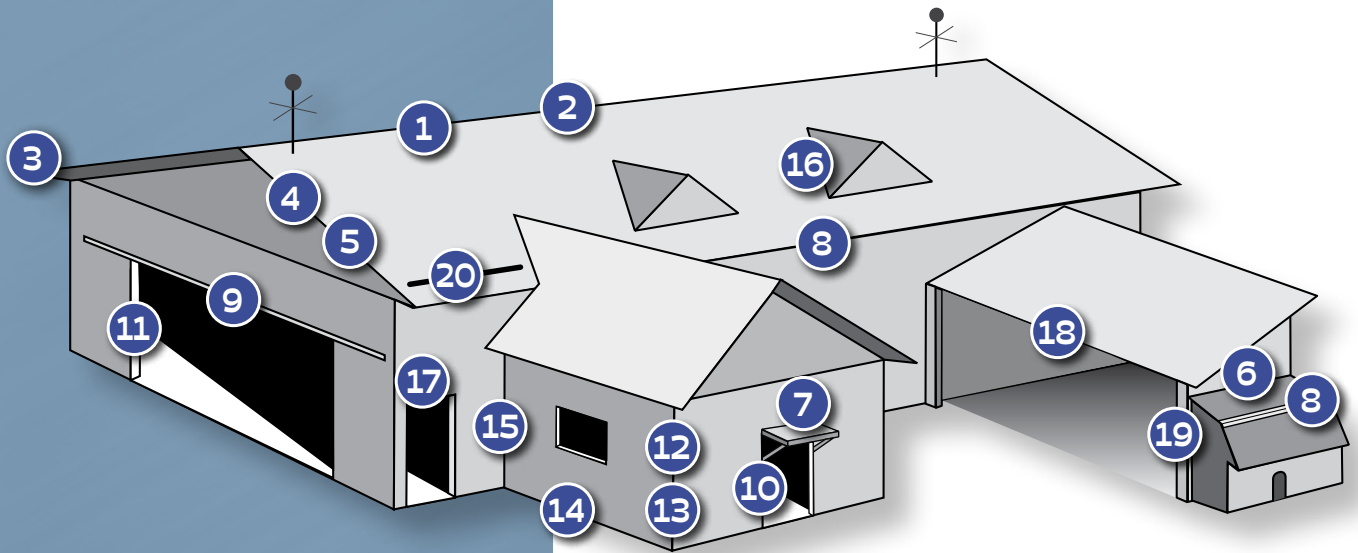

Trim Locator

- (1) Ridge Cap*
- (2) Ridge/Hip Cover
- (3) Soffit Trim
- (4) Mini Gable Trim
- (5) Gable Trim
- (6) Endwall/Transition*
- (7) Sidewall*
- (8) Eave Trim/Upper Gambrel
- (9) Door Track Cover*
- (10) "J" Channel*
- (11) Post Trim*
- (12) Outside Corner*
- (13) Small Outside Corner*
- (14) Rat Guard*
- (15) Inside Corner
- (16) "W" Valley*
- (17) Drip Cap
- (18) Drip Edge*
- (19) Overhead Door Trim
- (20) Snow Rail

*standard in-stock trims

Ridge Cap 12" & 16"

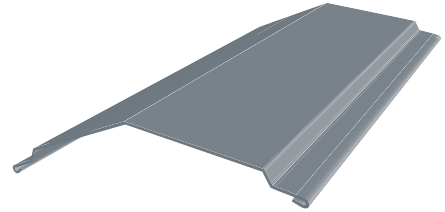
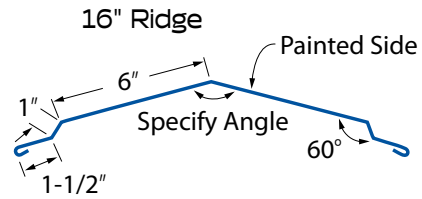
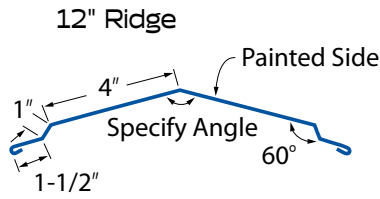

Ridge/Hip Cover

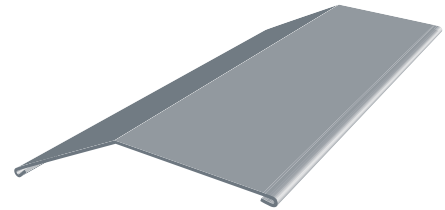
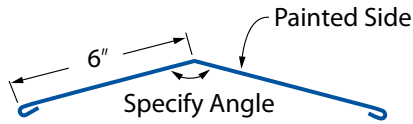

Soffit Trim

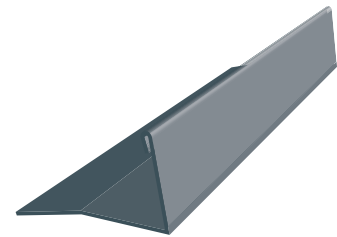
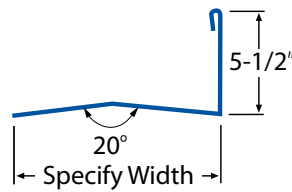

Mini Gable Trim

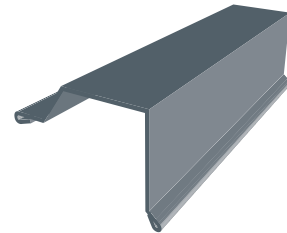
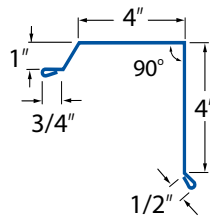

Gable Trim

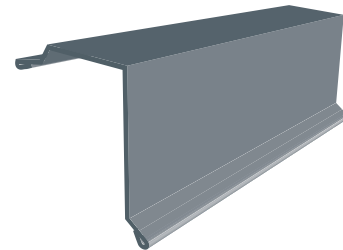
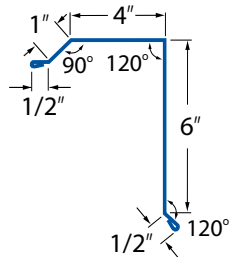

Endwall/Transition

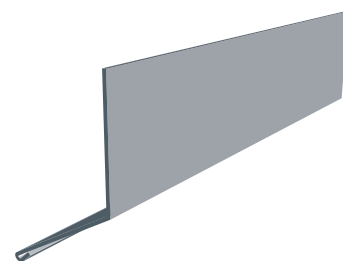
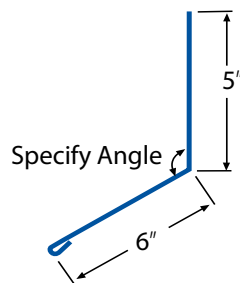

light gauge trims

Sidewall

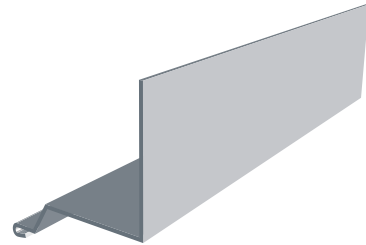
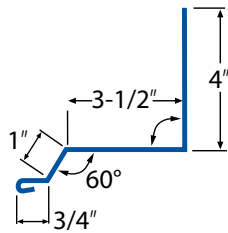

Eave Trim / Upper Gambrel

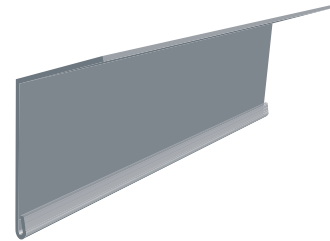
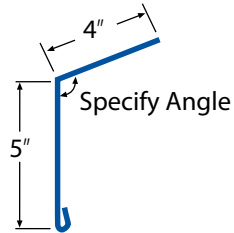

Door Track Cover (single)

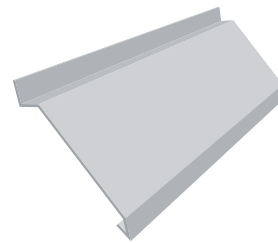
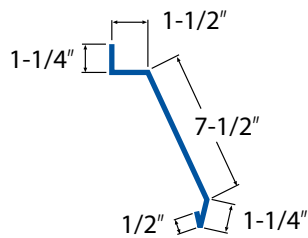

Door Track Cover (double)

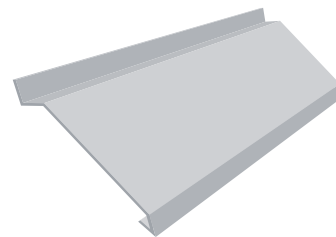
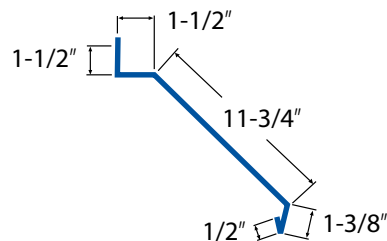

"J" Channel

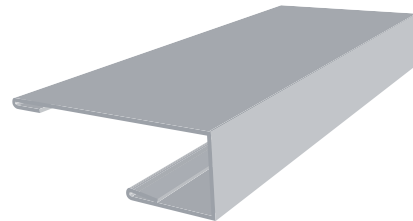
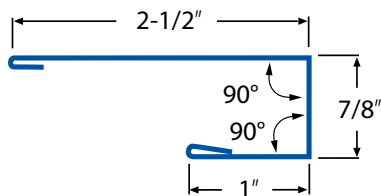

Post Trim

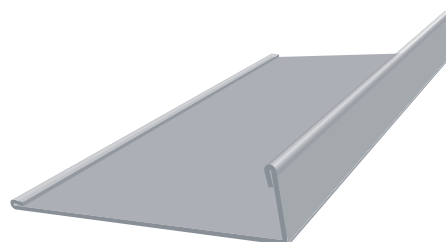
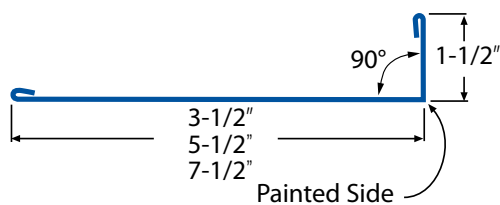

Outside Corner 2-1/2"

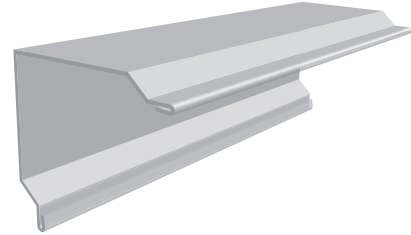
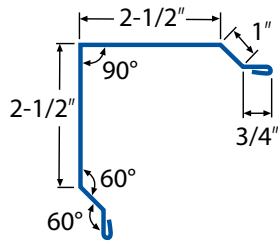

Outside Corner 4"

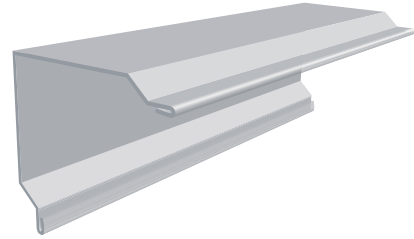
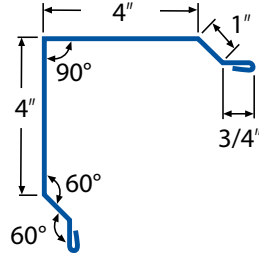

Rat Guard

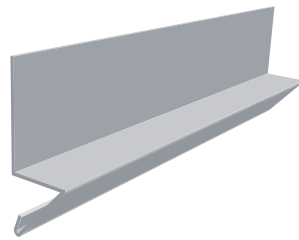
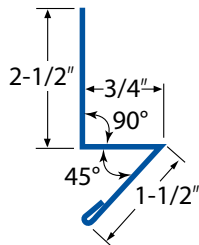

Inside Corner

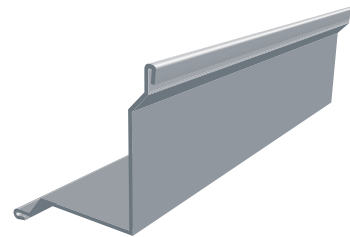
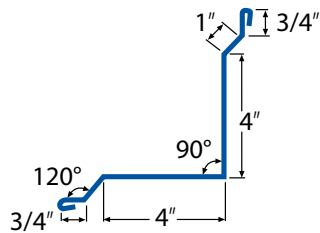

"W" Valley (with hem)

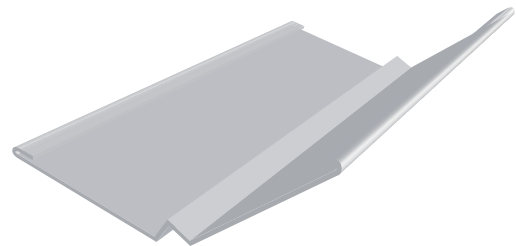
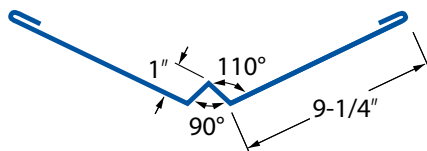

"W" Valley (without hem)

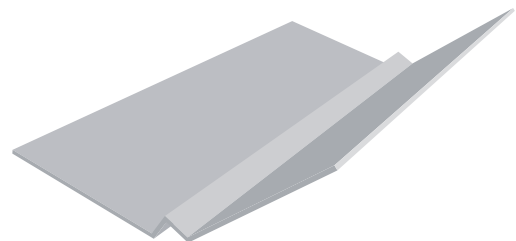
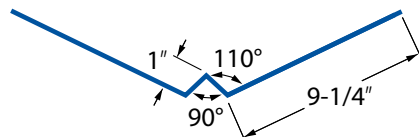

light gauge trims

Drip Cap

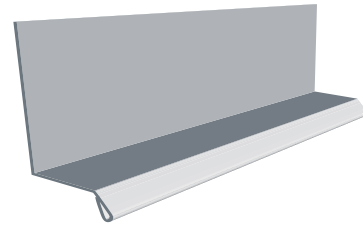
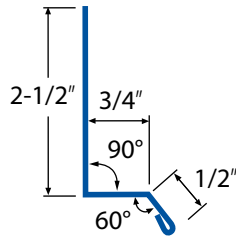

Drip Edge

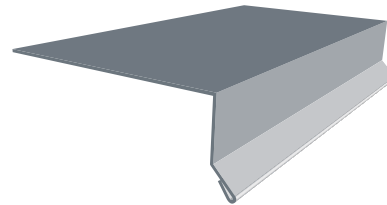
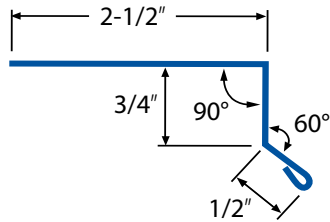

Overhead Door Trim

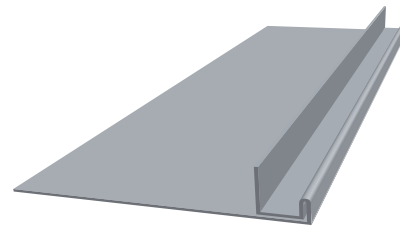
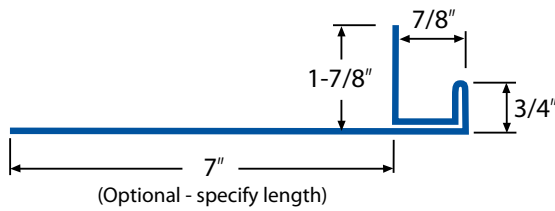

Base Trim

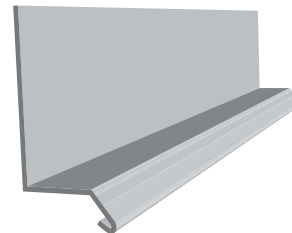
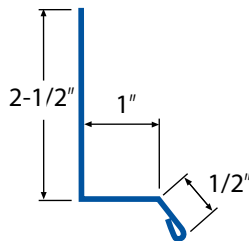

Fascia Trim

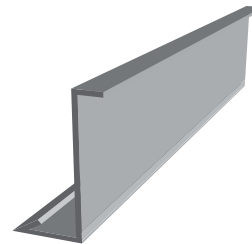
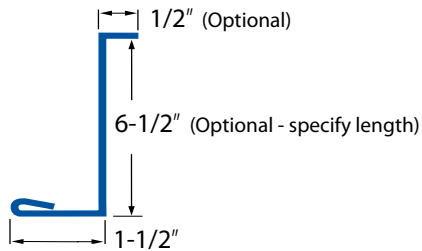

Double Angle

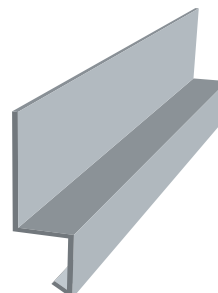
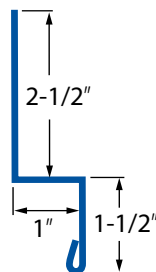

Snow Rail

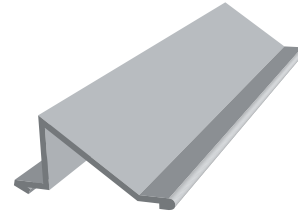
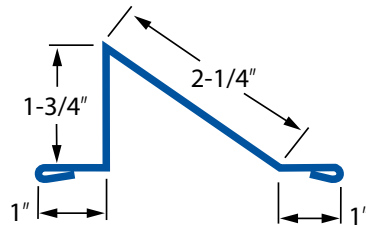

Formed Ridged Cover

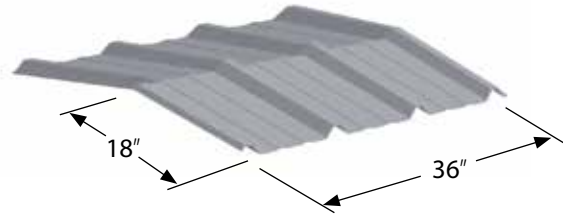

F & J Channel

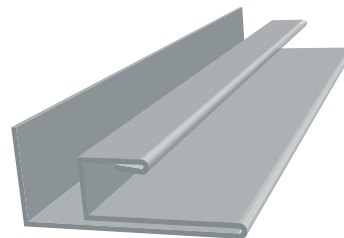
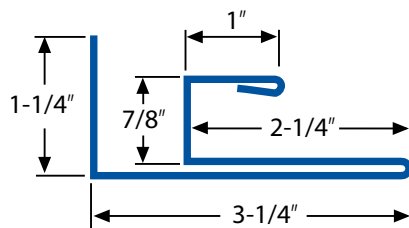

Chimney Counter Flashing

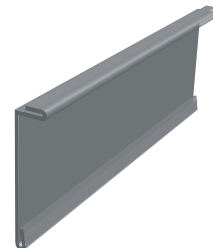
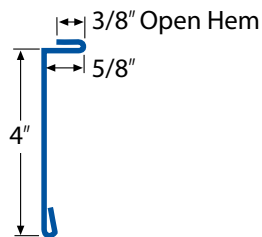

Accessories (pages 17-20)

Outside Closure

Inside Closure

Skylights

Butyl Tape

Pipe Flanges

Aerosol Touch Up Paint

Caulk

Fasteners

Bubble Insulation

Vinyl Back Insulation

standing seam trim locator

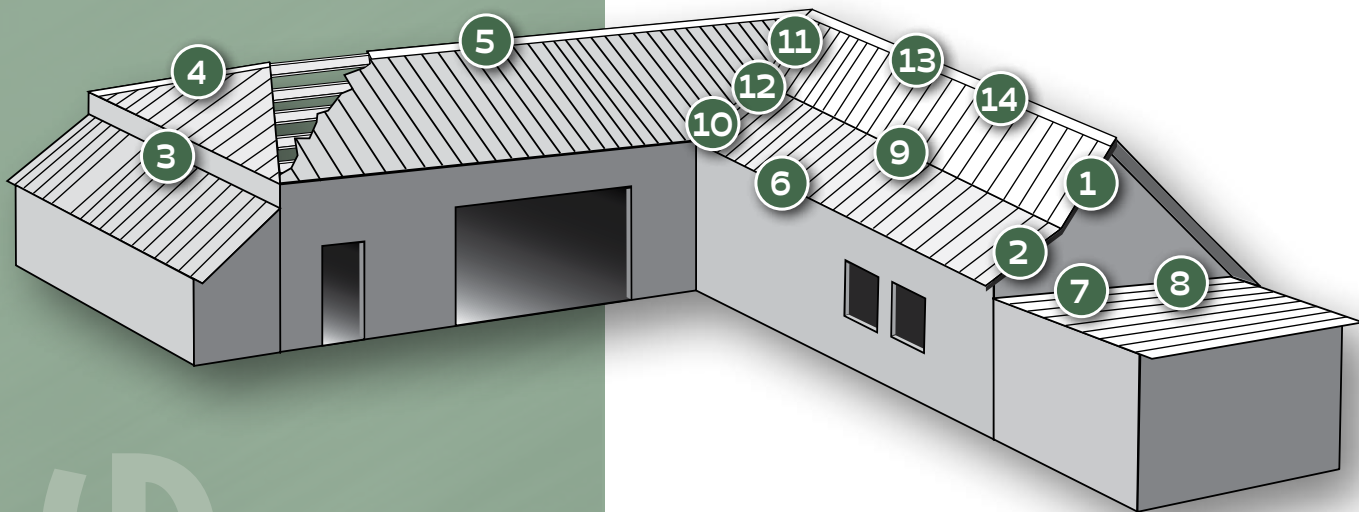

Trim Locator

- (1) Gable Trim
- (2) Step Gable Trim
- (3) Endwall Trim
- (4) Ridge/Hip Cover
- (5) Step Ridge Cap
- (6) Extended Eave Trim
- (7) Sidewall
- (8) Step Sidewall
- (9) Transition
- (10) "W" Valley
- (11) Offset Cleat
- (12) Valley Cleat
- (13) "Z" Closure
- (14) Vented "Z" Closure
- (15) Mechanical Lock Clip
- (16) Snap Lock Clip

STANDING SEAM

standing seam trims

Gable Trim

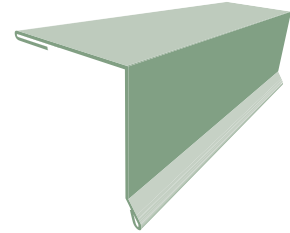
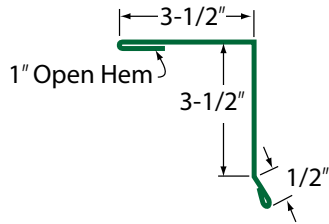

Step Gable Trim

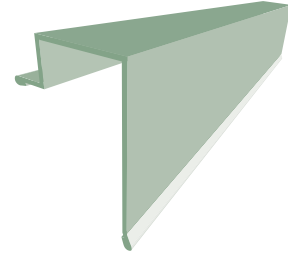
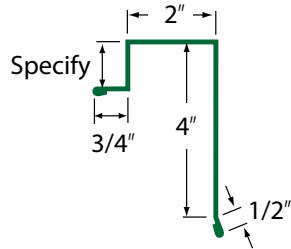

Endwall Trim

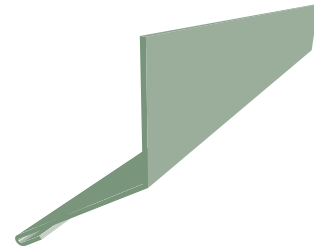
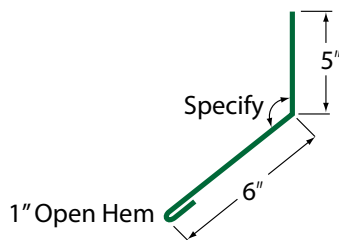

Ridge/Hip Cover

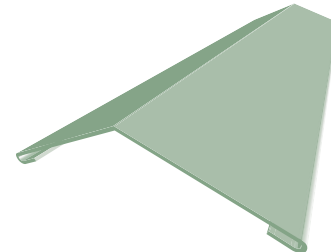
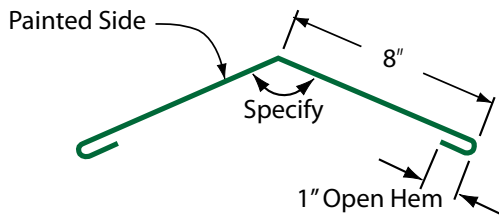

Step Ridge Cap

4" Step Ridge 00000

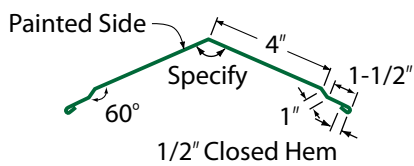

6" Step Ridge 00000

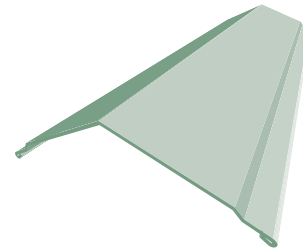
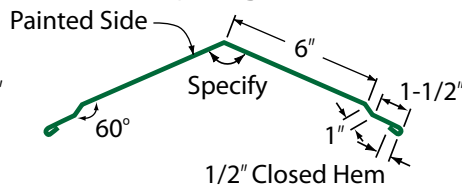

Extended Eave Trim

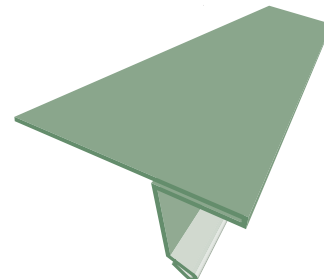
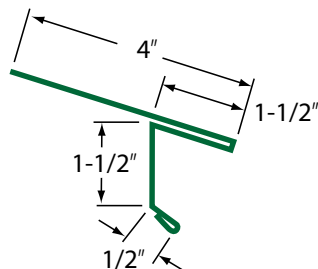

standing seam trims

Sidewall

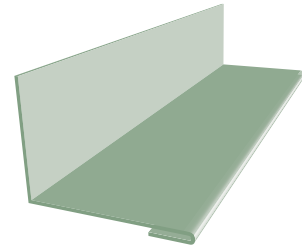
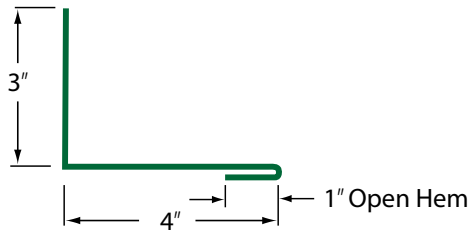

Step Sidewall

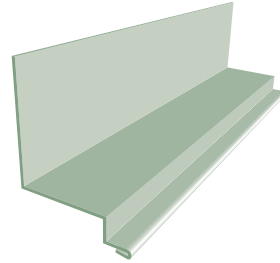
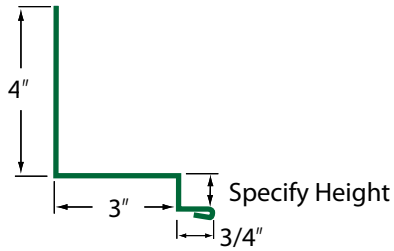

Transition

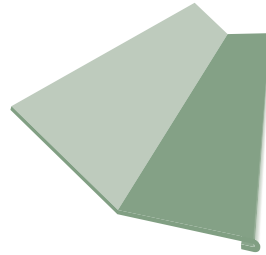
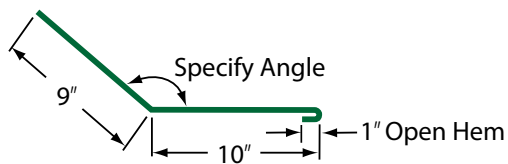

"W" Valley

00000

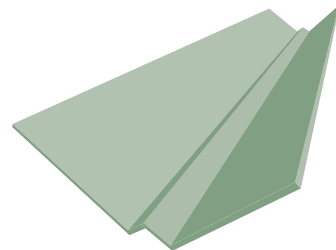
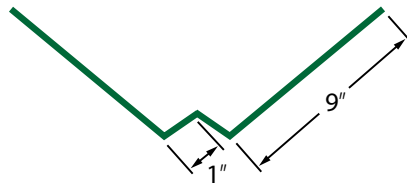

Offset Cleat

00000

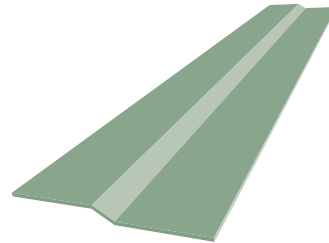
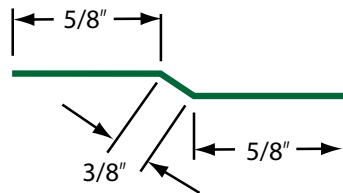

Valley Cleat

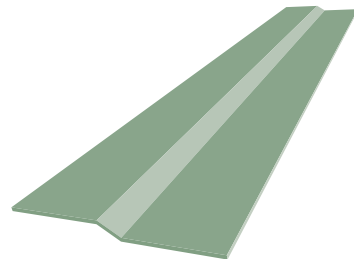
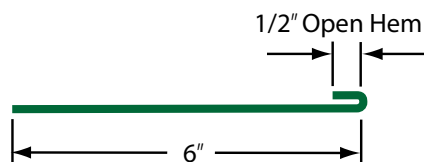

standing seam trims

"Z" Closure

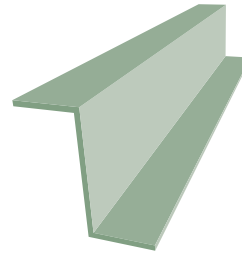
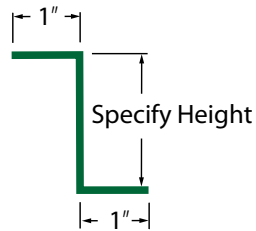

Vented "Z" Closure

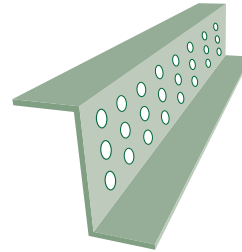
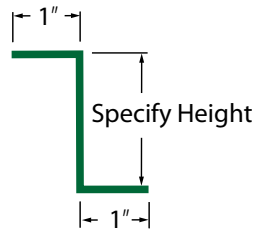

Mechanical Lock Clip

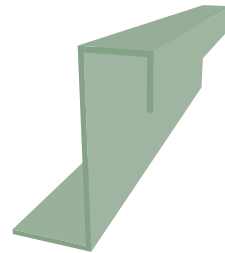
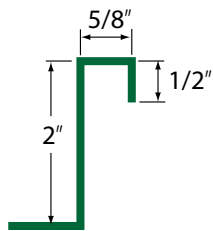

Snap Lock Clip

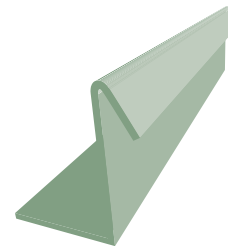
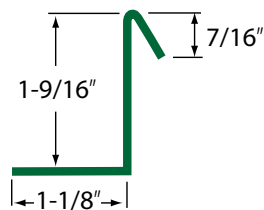

Accessories (pages 17-20)

Outside Closure

Inside Closure

Skylights

Butyl Tape

Pipe Flanges

Aerosol Touch Up Paint

Caulk

Fasteners

Bubble Insulation

Vinyl Back Insulation

secondary framing

CEE

Symmetrical Flanges

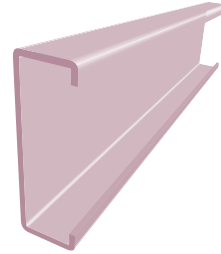
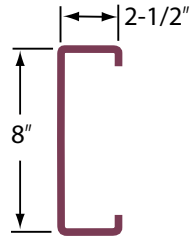

ZEE

Symmetrical Flanges

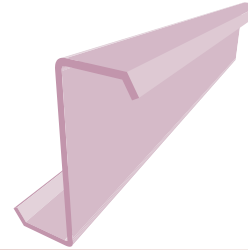
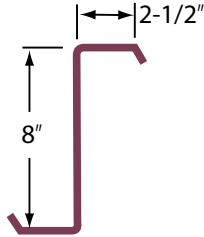

Base Angle

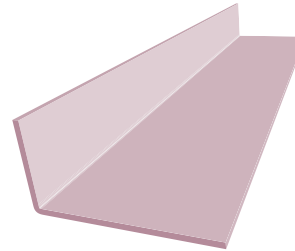
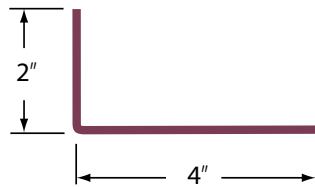

Hat Channel 7/8"

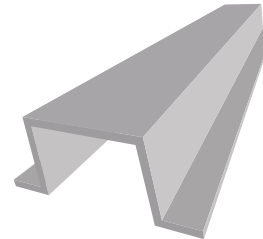
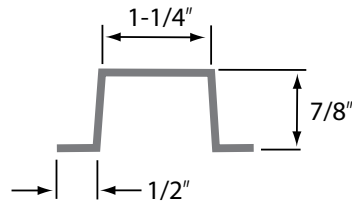

Hat Channel 1-1/2"

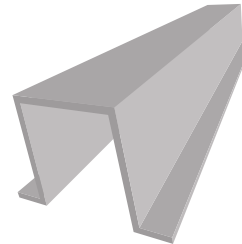
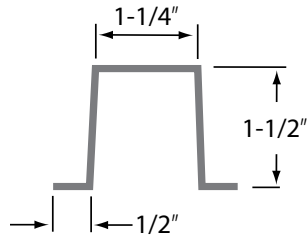

Specifications

| | GAUGE | SIZE | LENGTH | FINISH |
|-------------|-------|-----------|-----------|------------|
| CEE | 14 ga | 8" x 2.5" | 20' & 25' | Red Oxide |
| ZEE | 14 ga | 8" x 2.5" | 21' & 26' | Red Oxide |
| BASE ANGLE | 14 ga | 2" x 4" | 20' | Red Oxide |
| HAT CHANNEL | 18 ga | 7/8" | 20' | Galvanized |
| HAT CHANNEL | 18 ga | 1.5" | 20' | Galvanized |

Box/Sculptured Gutter Assembly

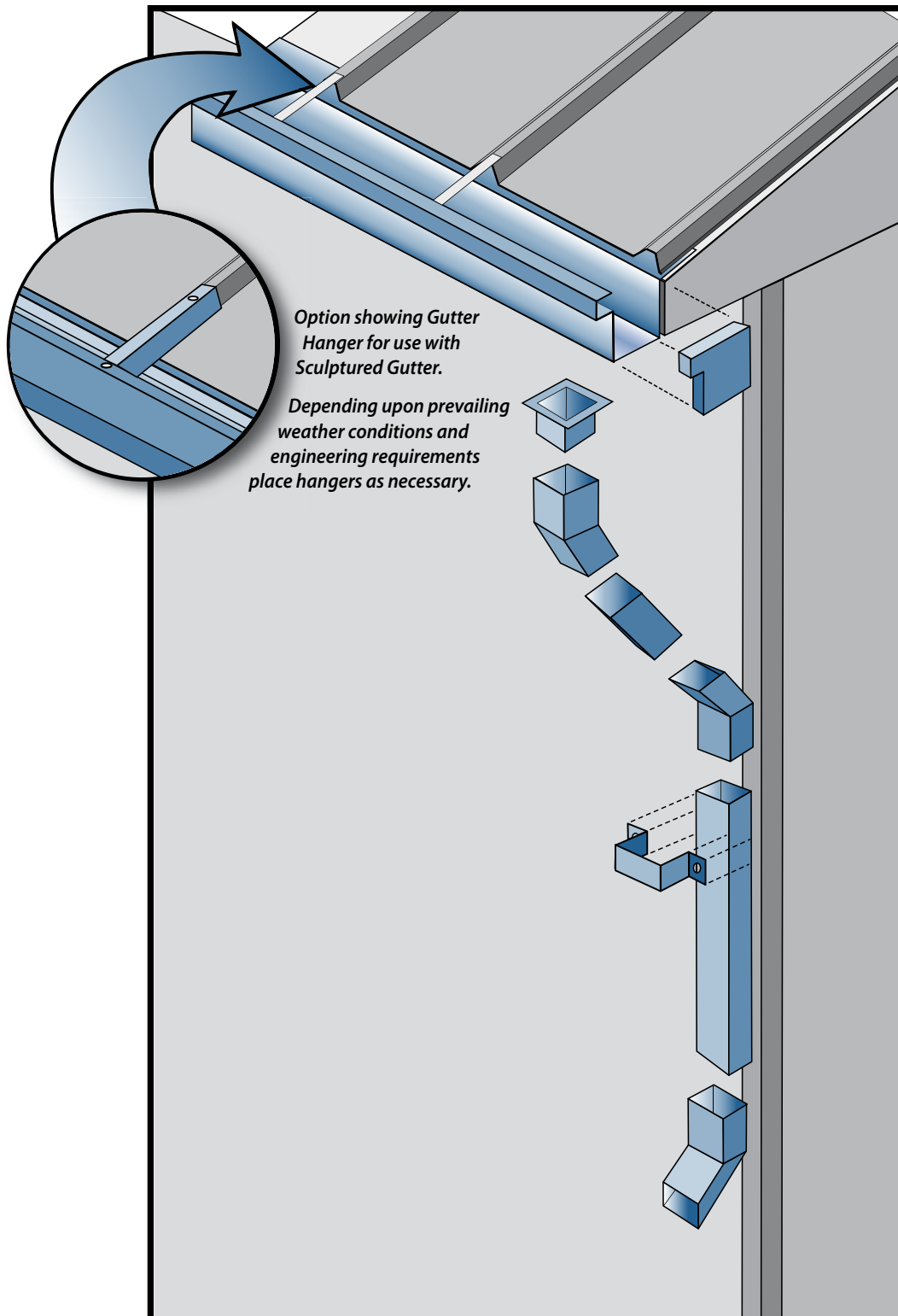

gutter and accessories

Sculptured Gutter

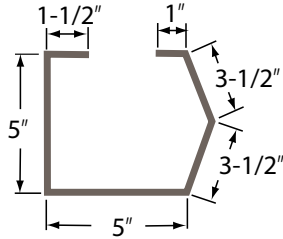

Sculptured Gutter Endcap

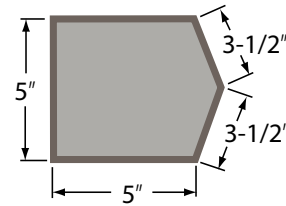

Box Gutter

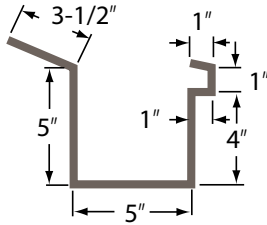

Box Gutter Endcap

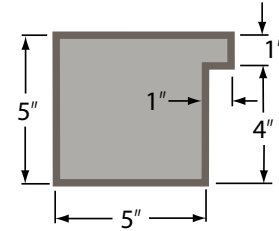

Gutter Hanger

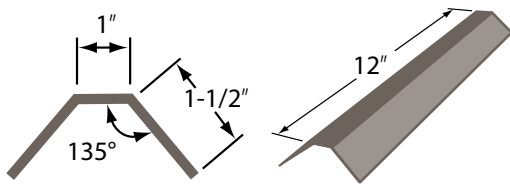

Gutter/Downspout Strap

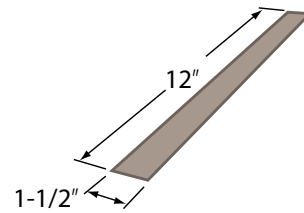

3" X 4" Downspout

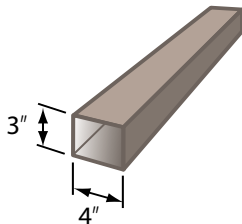

3" X 4" 45° Elbow

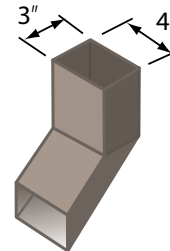

Outside Closure

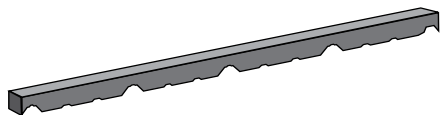

Inside Closure

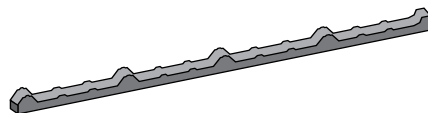

Skylight (Polycarbonate)

Tuff Rib
R-Panel



Butyl Tape

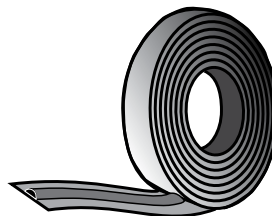

Pipe Flanges

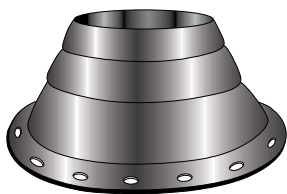

Aerosol Touch-Up Paint

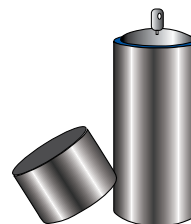

Caulk



TEK Screws

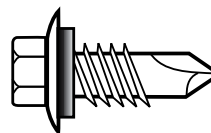

Wood Screws

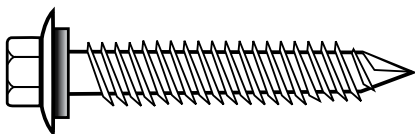

POP Rivets

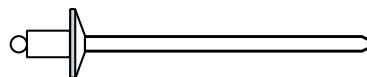

Double Bubble Insulation

4' x 125' foil/foil
4' x 125' foil/white
6' x 125' foil/white

Sizes vary
by location

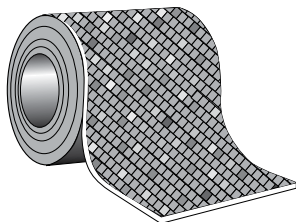

Vinyl Backed Insulation

2" thick 6' x 50'
3" thick 6' x 50'

Sizes vary
by location

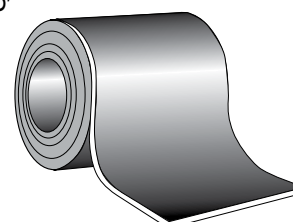

misc accessories / general tools

Hand Seamer
S3R / S6R



Caulk Gun
Premium / Economy



Hand Sweep Magnet



Aviation Snips
M2003 / M2006 / M2007



Andy Snips
MC12 / MC14



Turbo Shear TSHD



Shingle Ripper



Ratchet Straps
1" / 2"



Slap Stapler

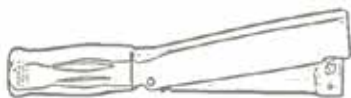

Wood and Metal Trusses

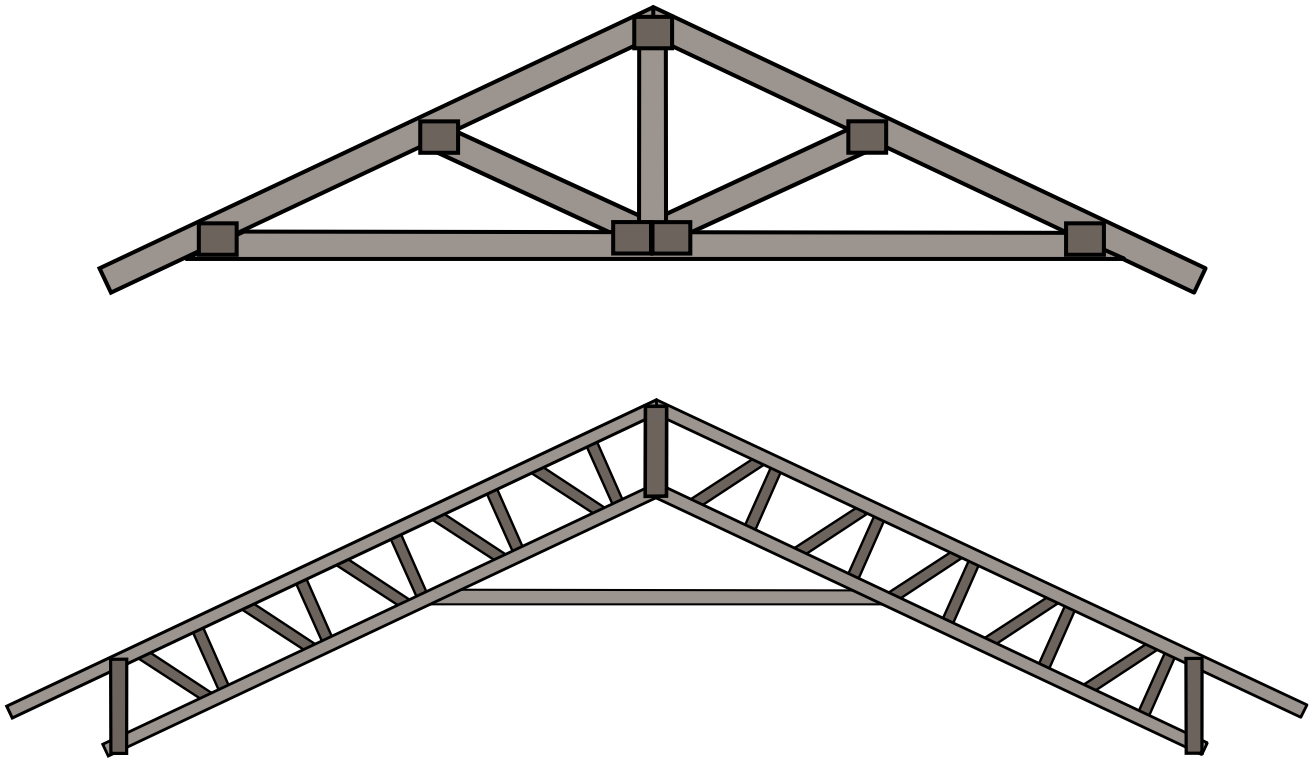

Additional Items (inquire)

Roll Up Garage Doors

Lumber

Sliding Door Systems

Composite Decking and Railing

Cougar Paw Boots

Colored Aluminum Coil

Insulation Tape

TEK Screws

Wood Screws

POP Rivets

Waterproof Tarp

Pipe Flange

1" x 4" Lathing

Doors and Windows

Profile Vent

Reciprocating Saw Blades

Utility Knives

Drill Bits

Driver Bits

Tape Measures

Rivet Guns

Chalk Lines

Leather and Rubber Coated Gloves

Nibblers

Power Shears

Ladder Racks

Roof Jacks

optional metal panels

1-1/4" CORRUGATED

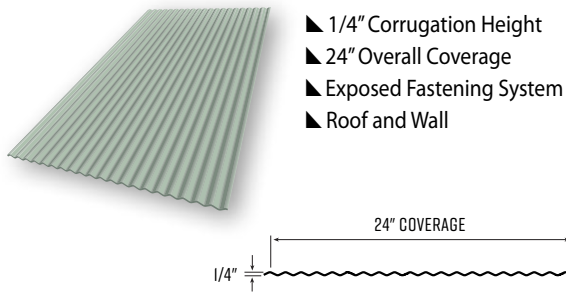

2-1/2" CORRUGATED

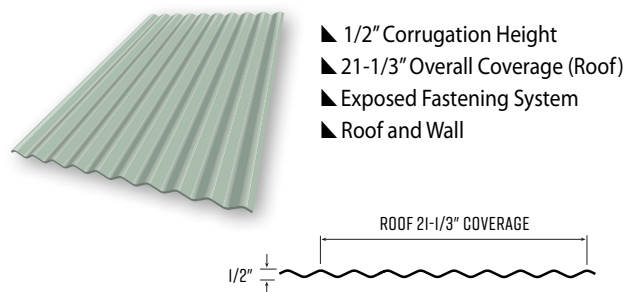

perforated panels

TUFF RIB (perforated)

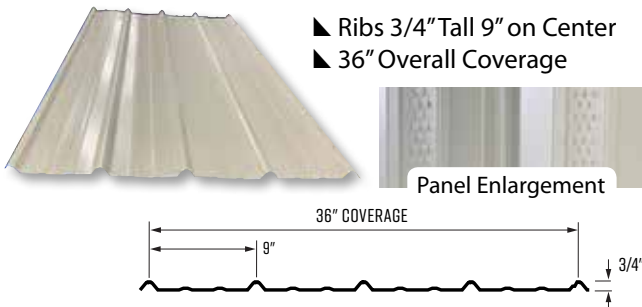

WAVE PANEL (perforated)

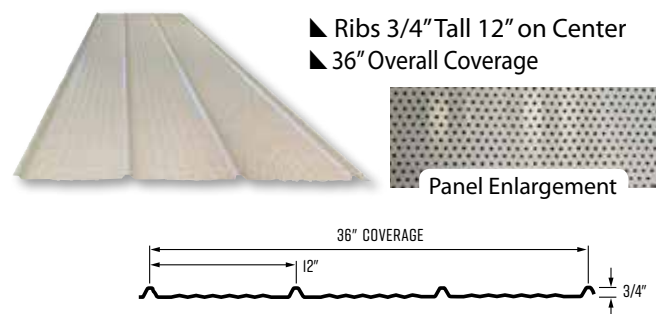

Hot Melt Adhesives 3388-P

Typical Physical Properties:

- Typical application temperature range: 350° - 400 F
- Viscosity: Approximately 16,000cps @ 350 F°
- Softening Point: Approximately 260° F1
- Color: Straw/Amber

General Uses and Product Characteristics:

HTM 3388-P is a high viscosity adhesive sealant with high heat resistance. It is used to bond and seal a variety of substrates including metals, plastics, and wood. The product demonstrates a high resistance to slump and yet is flexible under various temperature extremes. This product is approved under GM Material Spec. 998-2122 for automotive assembly requirements.

Storage and Handling Suggestions:

Store in cool, dry place in the original shipping container only. Keep container closed and tightly sealed when not in use to avoid contamination.

Chemistry: Synthetic Resin

Form: Pillows

Shelf Life: One year from the date of shipment

Standard Disclaimer: The data presented is based on tests standard to the adhesive industry. Because we have no control over the application process or the substrates used by the customer, HMT cannot certify the performance of the assembly this adhesive is used on. HMT will assume no responsibility for results obtained or for incidental or consequential damages arising from the use of this adhesive.

Drip Edge Folding Tool

- Bending Depth inches (mm): 1 1/2" (38.1)
- Bending Length inches (mm): 24" (61)
- Net Weight lbs. (kg.): 3.65 lbs (1.66)

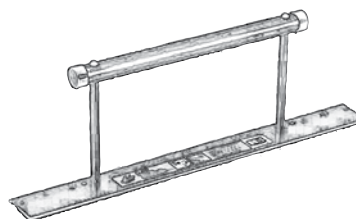

ESE001 Hand Seamer Single Lock Tool

The standard for locking the first stage of a double lock standing seam.

- Single lock hand seamer
- Forms the 90 degree bend
- For hard to reach places
- To start or finish (or an entire roof)
- Unique leverage design
- Lightweight and easy to use
- Will not scratch or peel paint
- Works on profiles 1/2" across, and 3/8" on the down leg

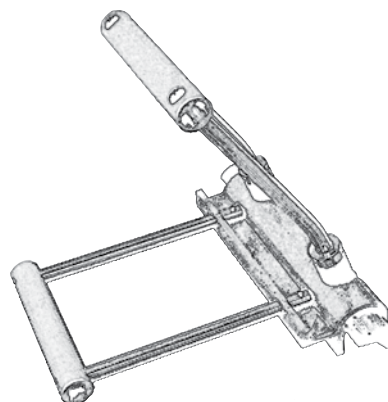

SS Industrial Seamer

Designed for 2" tall industrial/commercial grade roof panels.

- Front and rear safety auto-shutoffs included.
- Bi-directional 90° single lock seaming in one pass.
- Single direction 180° double lock seaming in one pass.
- Complete with seamer case and single lock hand tool.

Weight: 89 lbs.

Length: 24"

Milwaukee Motor

11.5 amps @ 110 volts

22-24 gauge capacity

416 SS Forming Rolls w/ optional slitting knives

Made in the USA

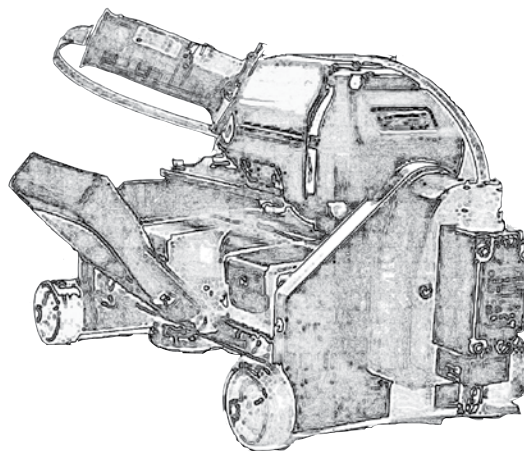

Ordering Special Trims

| ROOF SLOPE | | | | | | | | | | | | |
|---------------------------|------|------|------|------|------|------|------|------|------|-------|-------|-------|
| | 1:12 | 2:12 | 3:12 | 4:12 | 5:12 | 6:12 | 7:12 | 8:12 | 9:12 | 10:12 | 11:12 | 12:12 |
| Hip & Valley | 173° | 166° | 160° | 154° | 148° | 143° | 138° | 133° | 129° | 126° | 123° | 120° |
| Eave & Endwall | 94° | 99° | 104° | 108° | 112° | 116° | 120° | 123° | 126° | 129° | 132° | 135° |
| Ridge | 170° | 161° | 152° | 143° | 135° | 127° | 120° | 113° | 106° | 100° | 95° | 90° |
| Peak | 85° | 81° | 76° | 72° | 67° | 63° | 60° | 56° | 53° | 50° | 47° | 45° |

When ordering special trims...

- Specify dimensions of each segment
- Specify angle in degrees utilizing these charts
- Specify hems
- Specify painted side
- Specify the width (sum of all segments) of trim blank

Example...

- Specify dimensions of each segment (see right)
- Specify angle in degrees utilizing these charts (ex. 120°)
- Specify hems (ex. 1" open hem)
- Specify painted side (see right)
- Specify the width (sum of all segments) of trim (ex. $10'' + 10'' + 1'' = 21''$)

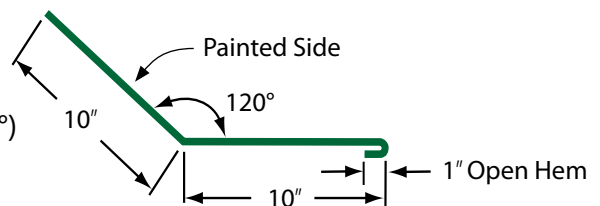

Transition (lower) Gambrel Flashing

| | | FROM | | | | | | | | | | | |
|----|-------|-------|-------|-------|------|------|------|------|------|------|------|------|------|
| | | 12:12 | 11:12 | 10:12 | 9:12 | 8:12 | 7:12 | 6:12 | 5:12 | 4:12 | 3:12 | 2:12 | 1:12 |
| TO | 1:12 | 139° | 142° | 144° | 147° | 150° | 154° | 158° | 162° | 168° | 172° | 177° | — |
| | 2:12 | 144° | 147° | 149° | 152° | 156° | 159° | 163° | 167° | 171° | 176° | | |
| | 3:12 | 149° | 151° | 154° | 157° | 160° | 163° | 167° | 171° | 175° | | | |
| | 4:12 | 153° | 156° | 158° | 161° | 164° | 168° | 172° | 176° | | | | |
| | 5:12 | 157° | 160° | 162° | 165° | 168° | 172° | 176° | | | | | |
| | 6:12 | 161° | 164° | 166° | 169° | 172° | 176° | | | | | | |
| | 7:12 | 165° | 167° | 170° | 173° | 176° | | | | | | | |
| | 8:12 | 168° | 171° | 173° | 176° | | | | | | | | |
| | 9:12 | 172° | 174° | 177° | | | | | | | | | |
| | 10:12 | 175° | 177° | | | | | | | | | | |
| | 11:12 | 177° | | | | | | | | | | | |
| | 12:12 | — | | | | | | | | | | | |

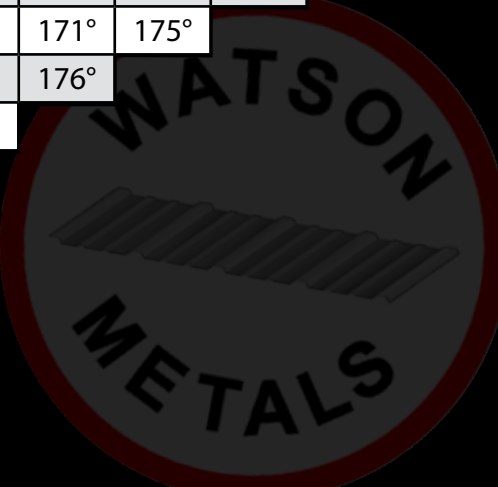

Upper Gambrel Flashing

| | | FROM | | | | | |
|----|-------|------|------|------|------|------|------|
| | | 1:12 | 2:12 | 3:12 | 4:12 | 5:12 | 6:12 |
| TO | 18:12 | 128° | 133° | 137° | 142° | 146° | 150° |
| | 17:12 | 129° | 134° | 139° | 143° | 147° | 151° |
| | 16:12 | 131° | 136° | 140° | 145° | 149° | 153° |
| | 15:12 | 133° | 138° | 142° | 147° | 151° | 155° |
| | 14:12 | 135° | 140° | 144° | 149° | 153° | 157° |
| | 13:12 | 137° | 142° | 146° | 151° | 155° | 159° |
| | 12:12 | 139° | 144° | 149° | 153° | 157° | 161° |
| | 11:12 | 142° | 147° | 151° | 156° | 160° | 164° |
| | 10:12 | 144° | 149° | 154° | 158° | 162° | 166° |
| | 9:12 | 147° | 152° | 157° | 161° | 165° | 169° |
| | 8:12 | 150° | 155° | 160° | 164° | 168° | 172° |
| | 7:12 | 154° | 159° | 163° | 168° | 172° | 175° |

Round Track & Sliding Doors



P. 800.766.2825 • F. 800.834.7447
www.cnbnhp.com

Keyhole Track

- Features:**
- Made out of 14-gauge galvanized steel
 - Keyholes punched every 2 feet
 - Handles doors weighing up to 600 lbs (when used with Dextrin Trolleys)
 - Available with brackets pre-riveted

Keyhole Brackets:



- Face-Mount Bracket (For Cover)** (Part # 646313)
Top-Mount Bracket (For Cover) (Part # 646319)
Face-Mount Bracket (Track Only) (Part # 646318)
Splice Collar (Part # 646314)

Quick Track

- Features:**
- Blends a 14-gauge galvanized steel track with a built-in 18-gauge, white finish cover (top-mount)
 - Protection for doors up to 4-1/2" thick
 - Only sold as pairs
 - Mount with at least 1-1/2" 10-gauge ring shank nails or 5/16" lag bolts
 - Can support weights up to 600 lbs.



Classic Round (Weatherstrip) Track

- Features:**
- Blends a 14-gauge galvanized steel track with a factory-riveted 16-gauge steel mounting strip (face-mount)
 - Mount with ring shank nails or 5/16" lag bolts
 - Can support weights up to 600 lbs.

Track Stock Codes

| Size | Keyhole Track | Quick Track | Classic Round Track | R.D. Tubular Track |
|---------|---------------|-------------|---------------------|--------------------|
| 8 Foot | 643856 | 711158 | 646361 | 646325 |
| 10 Foot | 643857 | 711159 | 646355 | 646327 |
| 12 Foot | 711061 | 711160 | 711133 | 646328 |
| 14 Foot | 711062 | 711161 | 711134 | 646329 |
| 16 Foot | 711063 | 711162 | 711135 | 646330 |
| 20 Foot | 711065 | 711164 | 711137 | 646331 |

Heavy Duty Tubular Track

- Features:**
- Made out of 13-gauge high carbon galvanized steel
 - Handles doors weighing up to 1200 lbs (when used with Dextrin Double Track Trolleys)

Heavy Duty Tubular Brackets:

(Brackets can also be used with Keyhole)



- Universal Side Bracket** (Part # 644309)
Ceiling Bracket (Part # 644322)
Bolt Hung Bracket (For use with angle brackets) (Part # 644321)
Universal Double Side Bracket (Part # 644311)

Round Track Trolleys

Part numbers reflect retail cartone parts

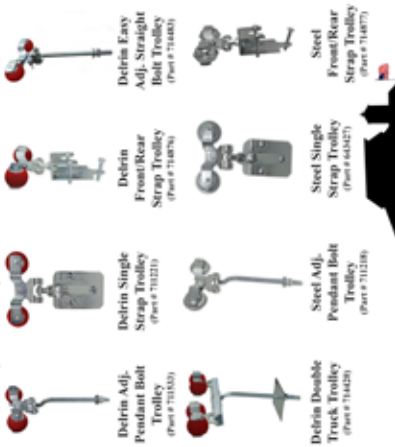

- Dextrin Adj. Pendant Bolt Trolley** (Part # 711653)
Dextrin Single Strap Trolley (Part # 711223)
Dextrin Front/Rear Strap Trolley (Part # 714875)
Dextrin Easy Adj. Straight Bolt Trolley (Part # 714874)
Steel Double Track Trolley (Part # 714426)
Steel Adj. Pendant Bolt Trolley (Part # 711219)
Steel Single Strap Trolley (Part # 643427)
Steel Front/Rear Strap Trolley (Part # 714873)

Products Made Proudly in the U.S.A.

Sliding Door Accessories



- Jamb Latch** (Part # 721062)
Gate, Stall and Door Latch (Part # 710605)
Offset Adj. Stay Roller (Part # 710606)
Can Latch (Part # 711063)
Door Pull (Part # 643181 & 710608)
Adjust-a-Stop (Part # 710604)
Center Door Stopper (Part # 644346)
Jamb Mount Stop (Part # 734625)
Stay Guide 471: 734675, 481: 734676, 1271: 792526

Sliding Door Sections

Kwik Frame® (100-Series & 200-Series): Developed as a complete, cohesive assembly, CannonBall's Kwik Frame system comes together in an easy, standard assembly. For straightforward construction on panels under 144 square feet.

Big Frame® (300-Series):

Designed to work together as a complete system, Big Frame Sliding Door components provide an easy, standard assembly for sliding door panels up to 20' x 20' in size.

| 150 Side Rail | 160 Double C-Profile | 170 Bottom Rail | 200 Side Rail | 210 Double C-Profile | 220 Bottom Rail | 230 Side Rail | 240 Double C-Profile | 250 Bottom Rail | 260 Side Rail | 270 Double C-Profile | 280 Bottom Rail |
|---------------|----------------------|-----------------|---------------|----------------------|-----------------|---------------|----------------------|-----------------|---------------|----------------------|-----------------|
| | | | | | | | | | | | |

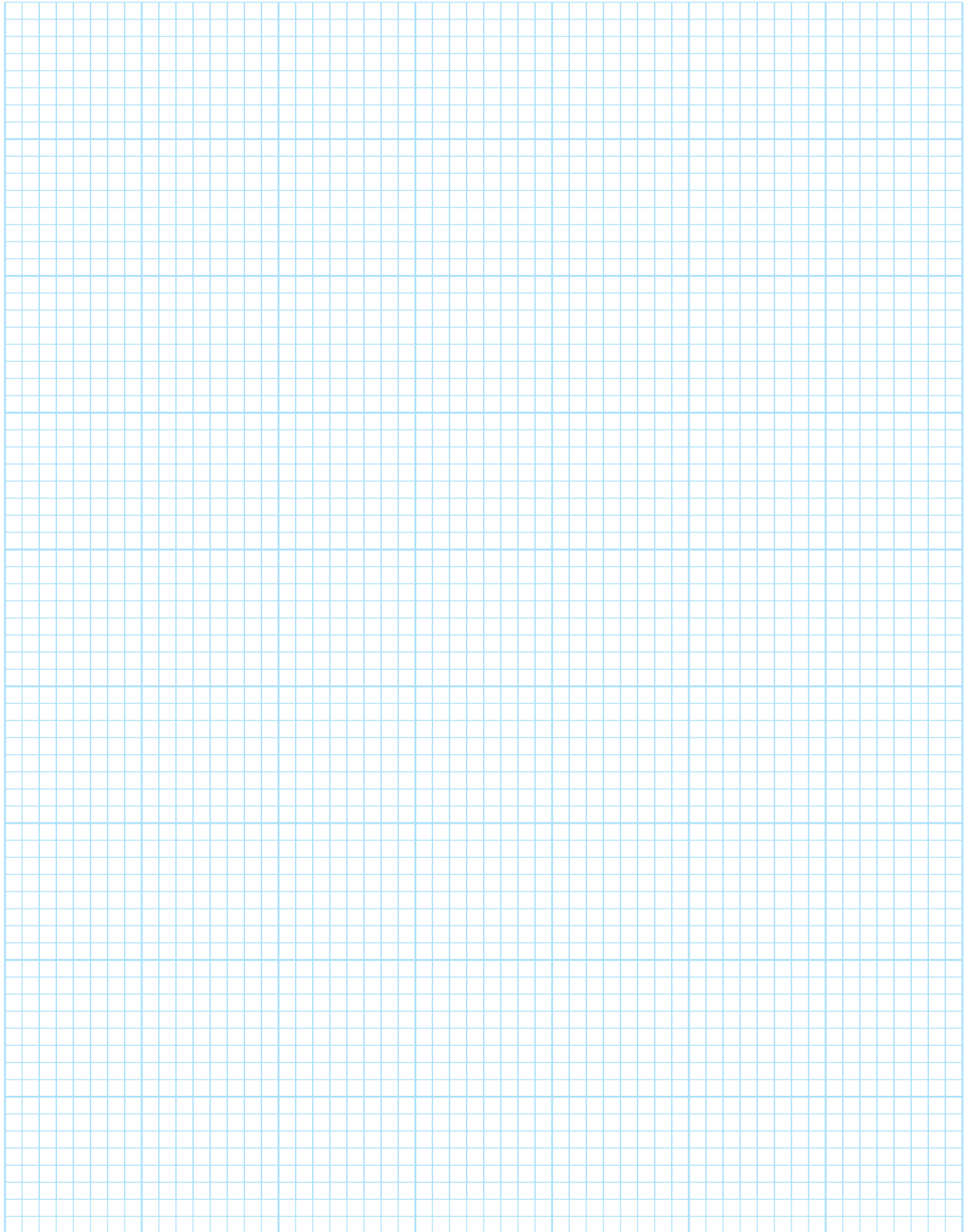

panel specifications

STANDING SEAM PANELS

Standing Seam is the Ultimate Metal Roofing System. Our Standing Seam is painted with the best paint available in the metal roofing industry. When installed properly, all fasteners on Standing Seam roofs will be hidden, virtually eliminating leakage caused by loose screws and dry rotted washers. Standing Seam is available in 29, 26 and 24 gauge painted, non-painted, and multiple profiles for different applications.

1" NAILER STRIP uses: residential/mansards/canopies

- ▲ 29 Gauge Kynar Painted Galvalume 40 Yr. Warranty
- ▲ 29 Gauge Bare Galvalume 25 Yr. Warranty
- ▲ 26 Gauge Kynar Painted Galvalume 40 Yr. Warranty
- ▲ 26 Gauge Bare Galvalume 25 Yr. Warranty
- ▲ 24 Gauge Kynar Painted Galvalume 40 Yr. Warranty
- ▲ 24 Gauge Bare Galvalume 25 Yr. Warranty
- ▲ 1" Rib Height
- ▲ 12" - 16" Overall Coverage
- ▲ Snap Locking Seams
- ▲ Hidden Fastener in Nailer Flange Fastening System
- ▲ Must be Installed over Solid Substrate Only

550 1-1/2" SNAP LOCK uses: residential/light commercial/mansards/canopies

- ▲ 26 Gauge Kynar Painted Galvalume 40 Yr. Warranty
- ▲ 26 Gauge Bare Galvalume 25 Yr. Warranty
- ▲ 24 Gauge Kynar Painted Galvalume 40 Yr. Warranty
- ▲ 24 Gauge Bare Galvalume 25 Yr. Warranty
- ▲ Ribs 1 1/2" Tall
- ▲ 12" - 19" Overall Coverage
- ▲ Snap Locking Seams
- ▲ Hidden Fastener with Clips 24" o/c Fastening System
- ▲ May be Installed over Solid Substrate or Purlins 24" o/c

450 1-1/2" SNAP LOCK uses: residential/light commercial/mansards/canopies

- ▲ 26 Gauge Kynar Painted Galvalume 40 Yr. Warranty
- ▲ 26 Gauge Bare Galvalume 25 Yr. Warranty
- ▲ 24 Gauge Kynar Painted Galvalume 40 Yr. Warranty
- ▲ 24 Gauge Bare Galvalume 25 Yr. Warranty
- ▲ Ribs 1 1/2" Tall
- ▲ 12" - 19" Overall Coverage
- ▲ Snap Locking Seams
- ▲ Hidden Fastener with Clips 24" o/c Fastening System
- ▲ Must be Installed over Solid Substrate

WATSON LOCK uses: commercial/industrial

- ▲ 24 Gauge Kynar Painted Galvalume 40 Yr. Warranty
- ▲ 24 Gauge Bare Galvalume 25 Yr. Warranty
- ▲ Ribs 2" Tall
- ▲ 12" - 18" Overall Coverage
- ▲ Single or Double Lock Mechanical Seams with Hot Melt Adhesive
- ▲ Hidden Fastener with Clips 24" o/c Fastening System
- ▲ May be Installed over Solid Substrate or Purlins 5' o/c

EXPOSED FASTENER PANELS

TUFF RIB uses: residential/agricultural/liner panel

The Tuff Rib Panel is the most commonly used metal siding and roofing panel in the residential and agriculture market today. It is also known by other names such as: Classic Rib, Ag-Panel, and D-Rib. It is most commonly fastened with screws in the flats of the panel. Tuff Rib is available in 29 or 26 gauge painted or non-painted material.

- ▲ 29 Gauge Painted Galvalume 40 Yr. Warranty
- ▲ 29 Gauge Bare Galvalume 25 Yr. Warranty
- ▲ 29 Gauge Painted No Warranty
- ▲ 26 Gauge Painted Galvalume 40 Yr. Warranty
- ▲ 26 Gauge Bare Galvalume 25 Yr. Warranty
- ▲ Ribs 3/4" Tall 9" on Center
- ▲ 36" Overall Coverage
- ▲ Sidelap with Anti-Siphon Groove

R-PANEL uses: residential/agricultural/commercial/liner panel

Also known as R Panel. PBR Panel is most commonly fastened with screws in the flats of the panel along with stitch screws in the overlap. PBR is available in 26 gauge painted or non-painted material and 24 gauge non-painted. It is available in 24 gauge painted by special order. PBR is able to span up to 6'.

- ▲ 26 Gauge Painted Galvalume 40 Yr. Warranty
- ▲ 26 Gauge Bare Galvalume 25 Yr. Warranty
- ▲ 24 Gauge Bare Galvalume 25 Yr. Warranty
- ▲ 24 Gauge Painted Galvalume 40 Yr. Warranty (Special Order)
- ▲ Ribs 1.1/4" Tall 12" on Center
- ▲ 36" Overall Coverage
- ▲ Sidelap with Anti-Siphon Groove
- ▲ Works Best on Solid Substrate or Purlins 60" o/c or Less

WAVE PANEL uses: commercial/agricultural/residential/liner panel

Are you looking for a roofing panel with the appearance of standing seam but the ease of exposed fasten? We have you covered! Watson Metals now has Watson Wave panel. Quality installation available.

- ▲ 29 Gauge Painted 40 Yr. Warranty
- ▲ 26 Gauge Painted 40 Yr. Warranty
- ▲ Ribs 12" on Center
- ▲ 36" Overall Coverage
- ▲ One less rib = less screws
- ▲ Mimics standing seam

Watson Metals is the only manufacturer in the Southeast offering this profile.

5V Crimp uses: commercial/agricultural/residential/liner panel

Are you looking for roofing panels that have that old style farmhouse look? Watson Metals can supply all of your 5V-crimp needs with custom cut panels and quality installation available as well.

- ▲ 29 Gauge Galvanized
- ▲ 29 Gauge Bare Galvalume 25 Yr. Warranty
- ▲ Ribs 7/16" Tall 12" on Center
- ▲ 24" Overall Coverage
- ▲ Screw Through Fastening System
- ▲ Works Best on Solid Substrate



Watson Metals, LLC
105 Duncan Chapel Rd
Auburn, KY 42206
Phone: 270-255-5314
Fax: 270-542-2142

Watson Metals, LLC
10363 Highway 46
Bon Aqua, TN 37035
Phone: 931-996-4110
Fax: 931-996-4383

Watson Metals, LLC
238 Interstate Drive
Manchester, TN 37355
Phone: 931-728-8185
Fax 931-728-8611
888-METAL-81

watsonmetalsllc.com